



Your saving is our concern



LED
LIGHT BY RLC

RLC ARCHITECTURAL LIGHTING



Your saving is our concern

We RIC Architectural Lighting (RLC) is young manufacturing company engage into innovative, qualitative and cost effective solid state lighting from last decade at Okhla Industrial Area, New Delhi.

Every month we add new product/design of architectural lighting by continuous research and development in various application like indoor lighting, landscape lighting, under water lighting, garden lighting, industrial lighting, office lighting ..etc.

Employing the best technology available and customer demand we always ready to customized lighting product to meet the clients requirement at a short notice with confidence which makes difference from other manufacturer .

RLC has state of art machines and equipment for entire production cycle from raw aluminum/stainless steel to final packing under in one roof.

RLC gives commitment to quality product and service and always prefer to use electronic components/circuit in our product from certified product from Confirming to European Norms (CE) and Bureau of Indian standards (BIS).





Your saving is our concern

About Solid State Lighting

Light Emitting Diode (LED) : A light-emitting diode (LED) is a semiconductor diode that emits light when electrically biased in the forward direction of the P-N Junctions.

COB (Chips on Board) : COB is a new technology of LED packaging for LED Light engine. Multi LED chips are packaged together as one lighting module. When it light up, it looks like a lighting panel.

Lumen (lm) : The lumen is a basic unit for measuring brightness, just as the gram is a basic unit for measuring mass. Lumen is related to the word luminous which means “bright” or “radiant”.

Lux : A unit of illumination equal to 1 lumen per square meter.

Color Rendering Index (CRI) : The Color Rendering Index CRI is the ability of a light source to replicate colors. it is measured against light generated by a reference light source of the same color temperature. It is measured as a number between 0 and 100.

Color Temperature (CCT): Color Temperature is a measurement in Degrees Kelvin that indicates the hue of a specific type of light source.

Beam Angle : The beam angle is the degree of width that light emits from a light source. In specific terms this is the angle between the opposing points on the beam axis where the intensity drops to 50% of its maximum.

Lens : Piece of PMMA, glass or other transparent substance that is used to form an image of an object by converging or diverging rays of light from the object. Because of the curvature of its surface, different rays of light are refracted through different angles.

LED Driver : Electronic device use as a power source to luminaries.

Current : The quantity of Electrons passing a given point. Its unit is Ampere.

Voltage : Electric pressure or force. its unit is volt.

Heat Sink : A heat sink is a thermal conductive metal device designed to absorb and disperse heat away from a high temperature object.

IP Rating : The two digits represent different forms of environmental influence.

- The first digit represents protection against ingress of solid objects.
- The second digit represents protection against ingress of liquids.

The larger the value of each digit, the greater the protection. As an example, a product rated IP67 would be better protected against environmental factors than another similar product rated as IP20.

IP	1st Digit Ingress of Solid Objects	2nd Digit Ingress of Liquids
0 0	No protection	No protection
1 1	Protected against solid objects over 50mm e.g. hands, large tools.	Protected against vertically falling drops of water or condensation.
2 2	Protected against solid objects over 12.5mm e.g. hands, large tools.	Protected against falling drops of water, if the case is disposed up to 15° from vertical.
3 3	Protected against solid objects over 2.5mm e.g. wire small tools.	Protected against sprays of water from any direction, even if the case is disposed up to 60° from vertical.
4 4	Protected against solid objects over 1.0mm e.g. wires.	Protected against splash water from any direction.
5 5	Limited protection against dust ingress. (no harmful deposit)	Protected against low pressure water jets from any direction. Limited ingress permitted.
6 6	Totally protected against dust ingress.	Protected against high pressure water jets from any direction Limited ingress permitted.
X 7	N/A	Protected against short periods of immersion in water.
X 8	N/A	Protected against long, durable periods of immersion in water.
X 9	N/A	Protected against close-range high pressure, high temperature spray downs.



Your saving is our concern

indoor
c o l l e c t i o n

LED PANEL SERIES



Your saving is our concern

Watt : 03W
 CCT : 3K / 4K / 6K
 Lumens : 270Lm
 Input Voltage : 220-240 V AC
 Shape : Round / Square
 Angle : 120°
 LED : SMD 2835
 Life Span : 50000 Hours
 CRI : >85
 PF : >.90
 Housing Material : Aluminium Powder Coated

- RLC-03-01RER • RLC-03-02RES
- RLC-03-03SUR • RLC-03-04SUS

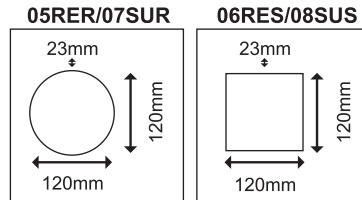
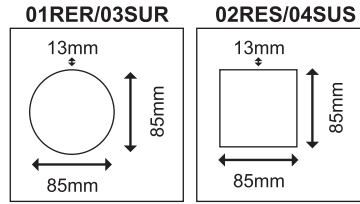

Watt : 06W
 CCT : 3K / 4K / 6K
 Lumens : 540 Lm
 Input Voltage : 220-240 V AC
 Shape : Round / Square
 Angle : 120°
 LED : SMD 2835
 Life Span : 50000 Hours
 CRI : >85
 PF : >.90
 Housing Material : Aluminium Powder Coated

- RLC-06-05RER • RLC-06-06RES
- RLC-06-07SUR • RLC-06-08SUS

Watt : 12W
 CCT : 3K / 4K / 6K
 Lumens : 1080 Lm
 Input Voltage : 220-240 V AC
 Shape : Round / Square
 Angle : 120°
 LED : SMD 2835
 Life Span : 50000 Hours
 CRI : >85
 PF : >.90
 Housing Material : Aluminium Powder Coated

- RLC-12-09RER • RLC-12-10RES
- RLC-12-11SUR • RLC-12-12SUS

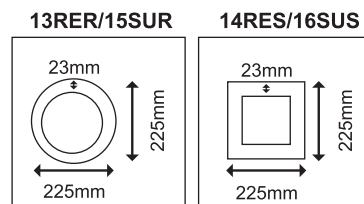
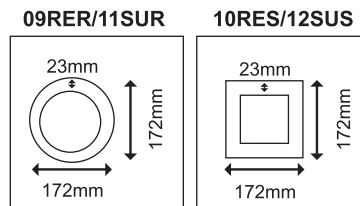

Watt : 18W
 CCT : 3K / 4K / 6K
 Lumens : 1620 Lm
 Input Voltage : 220-240 V AC
 Shape : Round / Square
 Angle : 120°
 LED : SMD 2835
 Life Span : 50000 Hours
 CRI : >85
 PF : >.90
 Housing Material : Aluminium Powder Coated

- RLC-18-13RER • RLC-18-14RES
- RLC-18-15SUR • RLC-18-16SUS

Note : RER- Recessed Round | RES-Recessed Square | SUR-Surface Round | SUS-Surface Square

**SPOTLIGHT AND
DOWNLIGHT SERIES**



Your saving is our concern

Watt : 03W
 CCT : 3K / 4K / 6K
 Lumens : 270Lm
 Input Voltage : 220-240 VAC
 Shape : Round
 Angle : 120°
 LED : SMD
 Life Span : 50000 Hours
 CRI : >85
 PF : >.90
 Housing Material : Aluminium Powder Coated

● **RLC-03-17RER**

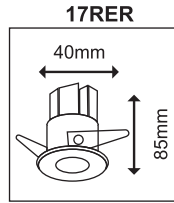

18RER/19RES 20RER/21RES

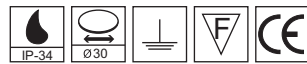
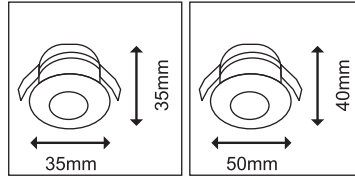

Watt : 01W / 03W
 CCT : 3K / 4K / 6K
 Lumens : 90 / 270 Lm
 Input Voltage : 220-240 V AC
 Shape : Round / Square
 Angle : 10° / 24° / 40° / 60°
 LED : SMD
 Life Span : 50000 Hours
 CRI : >85
 PF : >.90
 Housing Material : Aluminium Powder Coated

● **RLC-01-18RER** ● **RLC-01-19RES**
 ● **RLC-03-20RER** ● **RLC-03-21RES**

Watt : 10W / 20W
 CCT : 3K / 4K / 6K
 Lumens : 900 / 1800 Lm
 Input Voltage : 220-240 V AC
 Shape : Round
 Angle : 24°
 LED : COB
 Life Span : 50000 Hours
 CRI : >85
 PF : >.90
 Housing Material : Aluminium Powder Coated

● **RLC-10-22RER** ● **RLC-20-23RER**

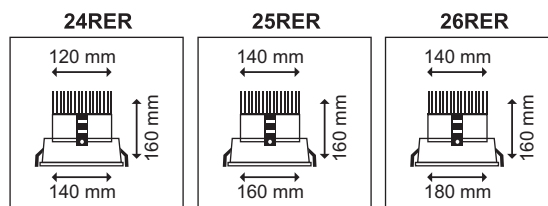
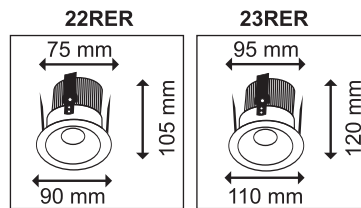

Watt : 25W / 40W / 50W
 CCT : 3K / 4K / 6K
 Lumens : 2400 / 3800 / 4800 / Lm
 Input Voltage : 220-240 V AC
 Shape : Round
 Angle : 24°
 LED : COB
 Life Span : 50000 Hours
 CRI : >85
 PF : >.90
 Housing Material : Aluminium Powder Coated

● **RLC-25-24RER** ● **RLC-40-25RER**
 ● **RLC-50-26RER**

Note : RER- Recessed Round | RES-Recessed Square

SPOTLIGHT AND DOWNLIGHT SERIES



Your saving is our concern

Watt : 5W / 10W / 15W / 25W
 CCT : 3K / 4K / 6K
 Lumens : 450 / 900 / 1400 / 2300 Lm
 Input Voltage : 220-240 V AC
 Shape : Round
 Angle : 24°
 LED : COB
 Life Span : 50000 Hours
 CRI : >85
 PF : >.90
 Housing Material : Aluminium Powder Coated

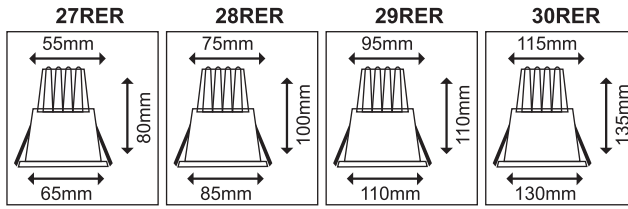

- RLC-05-27RER • RLC-10-28RER
- RLC-15-29RER • RLC-25-30RER

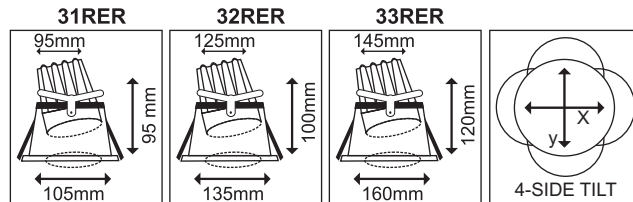

Watt : 10W / 15W / 25W
 CCT : 3K / 4K / 6K
 Lumens : 900 / 1400 / 2400 Lm
 Input Voltage : 220-240 V AC
 Shape : Round
 Angle : 24°
 LED : COB
 Life Span : 50000 Hours
 CRI : >85
 PF : >.90
 Housing Material : Aluminium Powder Coated

- RLC-10-31RER • RLC-15-32RER
- RLC-25-33RER



Watt : 12wX1 / 12wX2 / 12wX3
 CCT : 3K / 4K / 6K
 Lumens : 1100 / 2200 / 3400 Lm
 Input Voltage : 220-240 V AC
 Shape : Square
 Angle : 35°
 LED : COB
 Life Span : 50000 Hours
 CRI : >85
 PF : >.90
 Housing Material : Aluminium Powder Coated



- RLC-12-34RES • RLC-24-35RES
- RLC-36-36RES

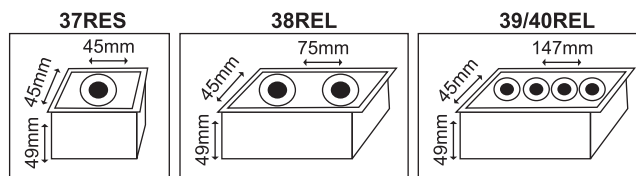
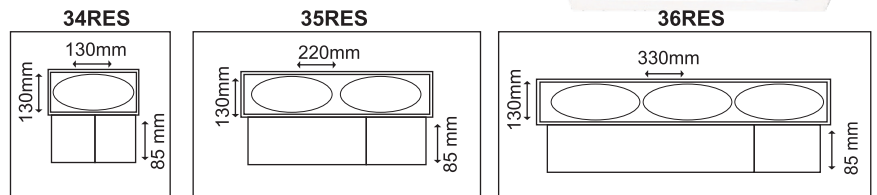

Watt : 2W / 4W / 10W / 20W
 CCT : 3K / 4K / 6K
 Lumens : 180 / 350 / 900 / 1800 Lm
 Input Voltage : 220-240 V AC
 Angle : 24°
 LED : SMD
 Life Span : 50000 Hours
 CRI : >85
 PF : >.90
 Housing Material : Aluminium Powder Coated

- RLC-02-37RES • RLC-4-38REL
- RLC-10-39REL • RLC-20-40REL



Note : RER- Recessed Round | RES-Recessed Square | REL-Recessed Linear

SPOTLIGHT AND WALL WASHER SERIES



Your saving is our concern

Watt : 9wx1 / 9wx2
 CCT : 3K / 4K / 6K
 Lumens : 850 / 1700 Lm
 Input Voltage : 220-240 VAC
 Angle : 35°
 LED : SMD
 Life Span : 50000 Hours
 CRI : >85
 PF : >.90
 Housing Material : Aluminium Powder Coated

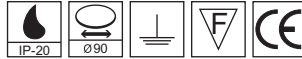
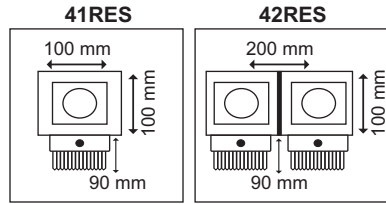

• **RLC-09-41RES** • **RLC-18-42RES**

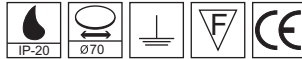

Watt : 6W / 9W / 15W / 30W / 40W
 CCT : 3K / 4K / 6K
 Lumens : 500 / 800 / 1400 / 2800 / 3800 Lm
 Input Voltage : 220-240 VAC
 Angle : 35°
 LED : COB
 Life Span : 50000 Hours
 CRI : >85
 PF : >.90
 Housing Material : Aluminium Powder Coated

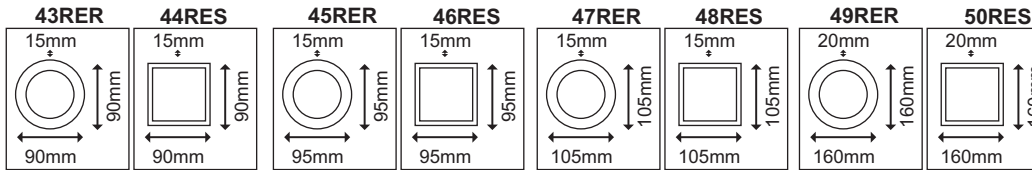

• **RLC-06-43RER** • **RLC-06-44RES**
 • **RLC-09-45RER** • **RLC-09-46RES**
 • **RLC-15-47RER** • **RLC-15-48RES**
 • **RLC-30-49RER** • **RLC-30-50RES**
 • **RLC-40-51RER** • **RLC-40-52RES**

Watt : 10W
 CCT : 3K / 4K / 6K
 Lumens : 950Lm
 Input Voltage : 220-240 VAC
 Angle : ASYMETRICAL
 LED : COB
 Life Span : 50000 Hours
 CRI : >85
 PF : >.90
 Housing Material : Aluminium Powder Coated

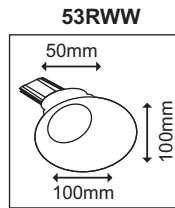

• **RLC-10-53RWW**

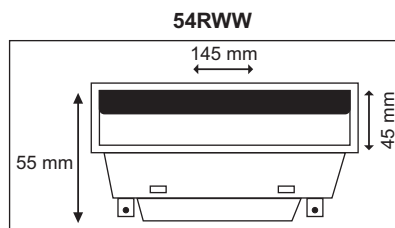

Watt : 10W
 CCT : 3K / 4K / 6K
 Lumens : 950 Lm
 Input Voltage : 220-240 VAC
 Angle : ASYMETRICAL
 LED : SMD
 Life Span : 50000 Hours
 CRI : >85
 PF : >.90
 Housing Material : Aluminium Powder Coated

• **RLC-10-54RWW**

Note : RER- Recessed Round | RES-Recessed Square | RWW-Recessed Wall Washer

**SPOTLIGHT AND
DOWNLIGHT SERIES**



Your saving is our concern

Watt : 7W / 12 W / 18W
 CCT : 3K / 4K / 6K
 Lumens : 650 / 1100 / 1700 Lm
 Input Voltage : 220-240 VAC
 Angle : 35°
 LED : COB
 Life Span : 50000 Hours
 CRI : >85
 PF : >.90
 Housing Material : Aluminium Powder Coated

- **RLC-07-55RER** • **RLC-12-56RER**
- **RLC-18-57RER**

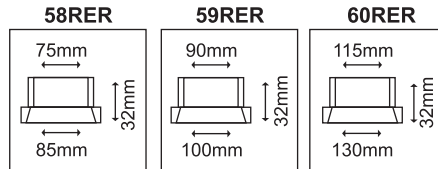
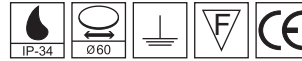
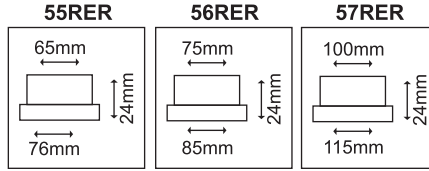

Watt : 7W / 12 W / 18W
 CCT : 3K / 4K / 6K
 Lumens : 650 / 1100 / 1700 Lm
 Input Voltage : 220-240 VAC
 Angle : 35°
 LED : COB
 Life Span : 50000 Hours
 CRI : >85
 PF : >.90
 Housing Material : Aluminium Powder Coated

- **RLC-07-58RER** • **RLC-12-59RER**
- **RLC-18-60RER**

Watt : 7W / 12 W / 18W
 CCT : 3K / 4K / 6K
 Lumens : 650 / 1100 / 1700 Lm
 Input Voltage : 220-240 VAC
 Angle : 35°
 LED : COB
 Life Span : 50000 Hours
 CRI : >85
 PF : >.90
 Housing Material : Aluminium Powder Coated

- **RLC-07-61RER** • **RLC-12-62RER**
- **RLC-18-63RER**

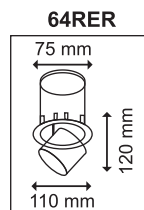
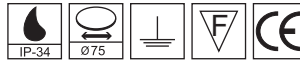
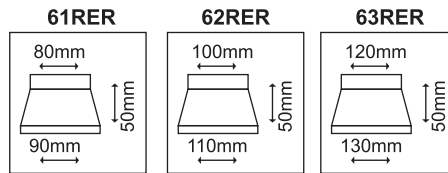

Watt : 12W
 CCT : 3K / 4K / 6K
 Lumens : 1150 Lm
 Input Voltage : 220-240 VAC
 Angle : 24°
 LED : COB
 Life Span : 50000 Hours
 CRI : >85
 PF : >.90
 Housing Material : Aluminium Powder Coated

- **RLC-12-64RER**

Note : RER- Recessed Round

**SPOTLIGHT AND
DOWNLIGHT SERIES**



Your saving is our concern

Watt : 10W
 CCT : 3K / 4K / 6K
 Lumens : 950 Lm
 Input Voltage : 220-240 VAC
 Angle : 24°
 LED : COB
 Life Span : 50000 Hours
 CRI : >85
 PF : >.90
 Housing Material : Aluminium Powder Coated

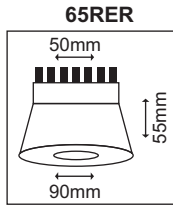

● **RLC-10-65RER**



Watt : 10W
 CCT : 3K / 4K / 6K
 Lumens : 950 Lm
 Input Voltage : 220-240 VAC
 Angle : 24°
 LED : COB
 Life Span : 50000 Hours
 CRI : >85
 PF : >.90
 Housing Material : Aluminium Powder Coated

● **RLC-10-66RER**

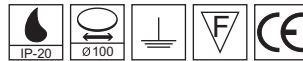
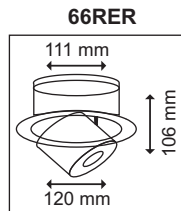

Watt : 7W / 12W / 18W
 CCT : 3K / 4K / 6K
 Lumens : 650 / 1100 / 1700 Lm
 Input Voltage : 220-240 VAC
 Angle : 35°
 LED : COB
 Life Span : 50000 Hours
 CRI : >85
 PF : >.90
 Housing Material : Aluminium Powder Coated

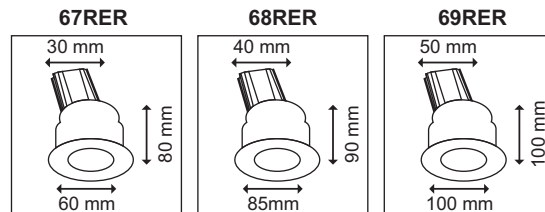

● **RLC-07-67RER** ● **RLC-12-68RER**
 ● **RLC-18-69RER**



PIR SENSOR



RANGE - 1.5mtr

MOVEMENT SENSOR



RANGE - 10cm

DOOR CONTROL SENSOR



RANGE - 10cm

Note : RER- Recessed Round

SURFACE SPOTLIGHT AND DOWNLIGHT SERIES



Your saving is our concern

Watt : 10W
 CCT : 3K / 4K / 6K
 Lumens : 950 Lm
 Input Voltage : 220-240 V AC
 Angle : 24°
 LED : SMD
 Life Span : 50000 Hours
 CRI : >85
 PF : >.90
 Housing Material : : Aluminium Powder Coated

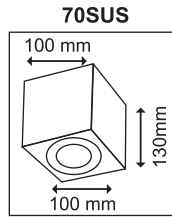

• **RLC-10-70SUS**

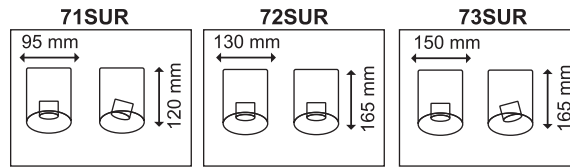
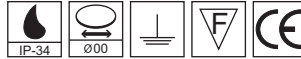

Watt : 10W / 20 W / 30 W
 CCT : 3K / 4K / 6K
 Lumens : 950 / 1900 / 2800 Lm
 Input Voltage : 220-240 V AC
 Angle : 24°
 LED : COB
 Life Span : 50000 Hours
 CRI : >85
 PF : >.90
 Housing Material : : Aluminium Powder Coated

• **RLC-10-71SUR** • **RLC-20-72SUR**
 • **RLC-30-73SUR**

Watt : 30W / 40W / 50W
 CCT : 3K / 4K / 6K
 Lumens : 2000 / 3000 / 4000 Lm
 Input Voltage : 220-240 V AC
 Angle : 24°
 LED : COB
 Life Span : 50000 Hours
 CRI : >85
 PF : >.90
 Housing Material : Aluminium Powder Coated

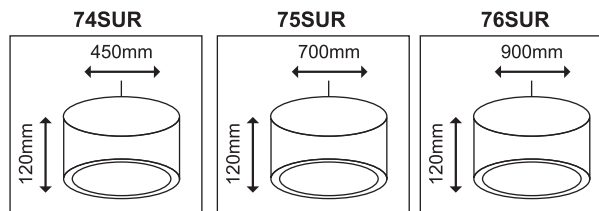

• **RLC-30-74SUR** • **RLC-40-75SUR**
 • **RLC-50-76SUR**

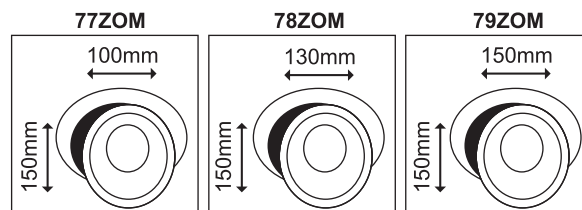

Watt : 10W / 20 W / 30 W
 CCT : 3K / 4K / 6K
 Lumens : 950 / 1900 / 2800 Lm
 Input Voltage : 220-240 V AC
 Angle : 24°
 LED : COB
 Life Span : 50000 Hours
 CRI : >85
 PF : >.90
 Housing Material : : Aluminium Powder Coated

• **RLC-10-77ZOM** • **RLC-20-78ZOM**
 • **RLC-30-79ZOM**

Note : RER- Recessed Round | SUR-Surface Round | SUS-Surface Square | ZOM-Scoop & Swivel

TRACK SPOT SERIES



Your saving is our concern

Watt : 10W
 CCT : 3K / 4K / 6K
 Lumens : 950 Lm
 Input Voltage : 220-240 VAC
 Angle : 24°
 LED : COB
 Life Span : 50000 Hours
 CRI : >85
 PF : >.90
 Housing Material : Aluminium Powder Coated

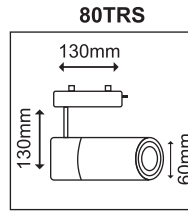

• **RLC-10-80TRS**

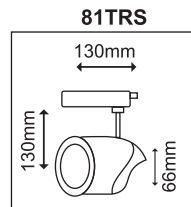
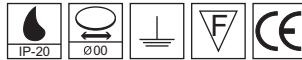

Watt : 15W
 CCT : 3K / 4K / 6K
 Lumens : 1450 Lm
 Input Voltage : 220-240 VAC
 Angle : 24°
 LED : COB
 Life Span : 50000 Hours
 CRI : >85
 PF : >.90
 Housing Material : Aluminium Powder Coated

• **RLC-15-81TRS**



Watt : 20W / 30 W
 CCT : 3K / 4K / 6K
 Lumens : 1900 / 2800 Lm
 Input Voltage : 220-240 VAC
 Angle : 24°
 LED : COB
 Life Span : 50000 Hours
 CRI : >85
 PF : >.90
 Housing Material : Aluminium Powder Coated

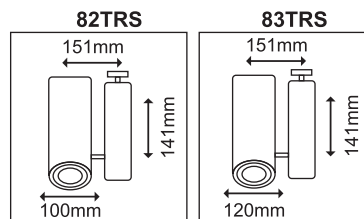

• **RLC-20-82TRS** • **RLC-30-83TRS**

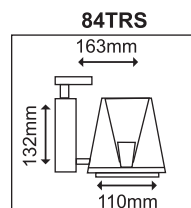

Watt : 40W
 CCT : 3K / 4K / 6K
 Lumens : 3800 Lm
 Input Voltage : 220-240 VAC
 Angle : 24°
 LED : COB
 Life Span : 50000 Hours
 CRI : >85
 PF : >.90
 Housing Material : Aluminium Powder Coated

• **RLC-40-84TRS**



Note : TRS- Track Spot

**OFFICE LIGHT
SERIES**



Your saving is our concern

Watt : 18W / 36 W
 CCT : 3K / 4K / 6K
 Lumens : 1700/ 3300Lm
 Input Voltage : 220-240 VAC
 Angle : 120°
 LED : SMD
 Life Span : 50000 Hours
 CRI : >85
 PF : >.90
 Housing Material : Aluminium Powder Coated

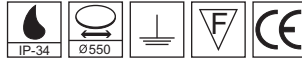
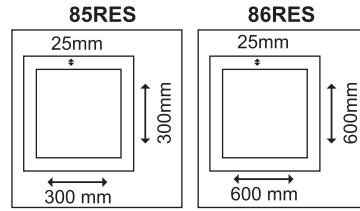

• **RLC-18-85RES** • **RLC-36-86RES**

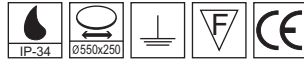
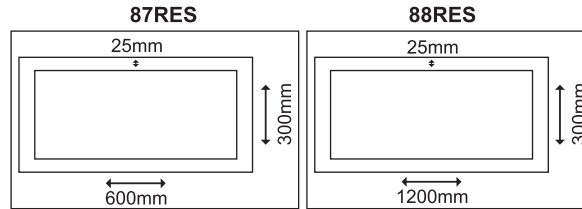

Watt : 18W / 36 W
 CCT : 3K / 4K / 6K
 Lumens : 1700/ 3300Lm
 Input Voltage : 220-240 VAC
 Angle : 120°
 LED : SMD
 Life Span : 50000 Hours
 CRI : >85
 PF : >.90
 Housing Material : Aluminium Powder Coated

• **RLC-18-87RES** • **RLC-36-88RES**

Watt : 36 W
 CCT : 3K / 4K / 6K
 Lumens : 3300Lm
 Input Voltage : 220-240 VAC
 Angle : 120°
 LED : SMD
 Life Span : 50000 Hours
 CRI : >85
 PF : >.90
 Housing Material : Aluminium Powder Coated

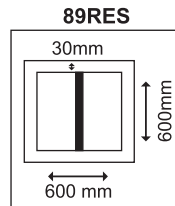

• **RLC-36-89RES**

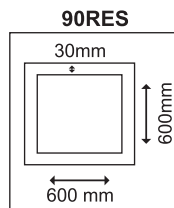
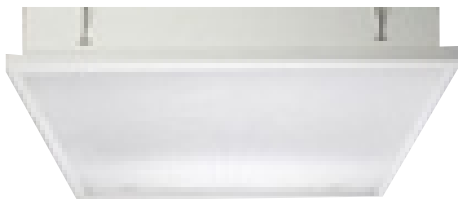

Watt : 36 W
 CCT : 3K / 4K / 6K
 Lumens : 3300Lm
 Input Voltage : 220-240 VAC
 Angle : 120°
 LED : SMD
 Life Span : 50000 Hours
 CRI : >85
 PF : >.90
 Housing Material : Aluminium Powder Coated

• **RLC-36-90RES**

Note : RES-Recessed Square

RETROFIT LAMP SERIES



Your saving is our concern

Watt : 14 W / 28 W
 CCT : 3K / 4K / 6K
 Lumens : 1300/ 2600Lm
 Input Voltage : 220-240 VAC
 Angle : 120°
 LED : SMD
 Life Span : 50000 Hours
 CRI : >85
 PF : >.90
 Housing Material : Aluminium Powder Coated

• **RLC-14-91RES** • **RLC-28-92RES**

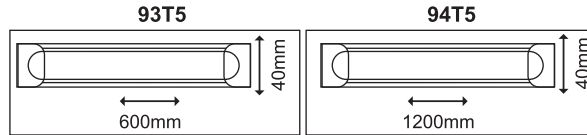
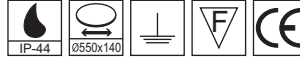
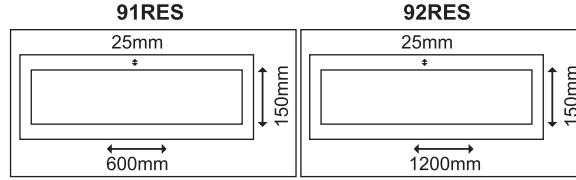

Watt : 9 W / 18 W
 CCT : 3K / 4K / 6K
 Lumens : 850 / 1700Lm
 Input Voltage : 220-240 VAC
 Angle : 120°
 LED : SMD
 Life Span : 50000 Hours
 CRI : >85
 PF : >.90
 Housing Material : Aluminium Powder Coated

• **RLC-09-93T5** • **RLC-18-94T5**

Watt : 18 W
 CCT : 3K / 4K / 6K
 Lumens : 1700 Lm
 Input Voltage : 220-240 VAC
 Angle : 120°
 LED : SMD
 Life Span : 50000 Hours
 CRI : >85
 PF : >.90
 Housing Material : Aluminium Anodise

• **RLC-18-95PL**

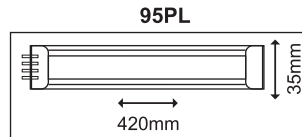

Watt : 3W / 6W / 8W / 11W
 CCT : 3K / 4K / 6K
 Lumens : 270 / 550/ 700 / 1000 Lm
 Input Voltage : 220-240 VAC
 Angle : 24° / 24°
 LED : SMD
 Life Span : 50000 Hours
 CRI : >85
 PF : >.90
 Housing Material : Aluminium Powder Coated

• **RLC-03-96MR** • **RLC-06-97MR**
 • **RLC-08-98MR** • **RLC-11-99MR**

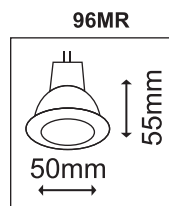

Note : RES-Recessed Square | T5-Tube Light | MR-MR-16 Bulb

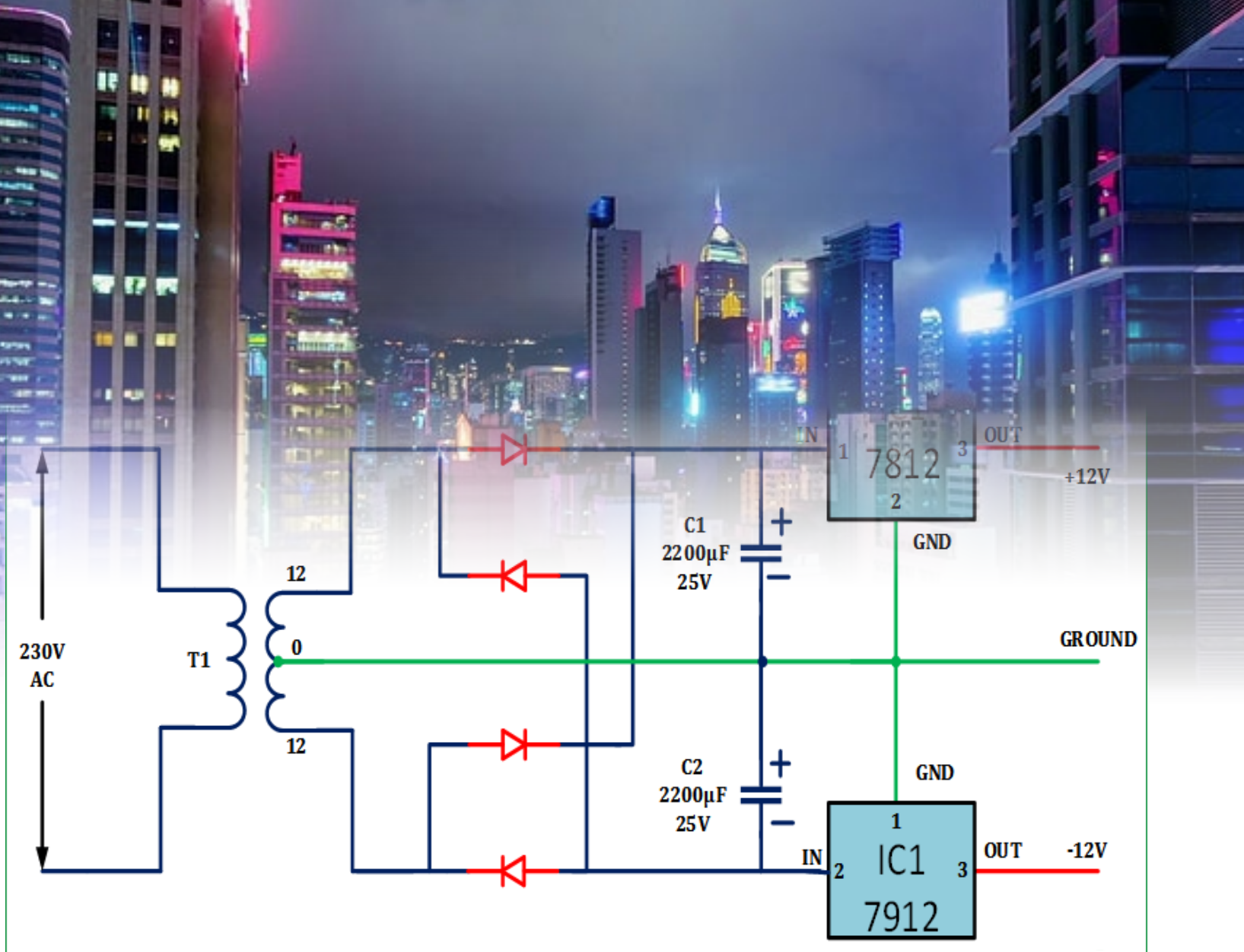

IP 67/NonDimmable



IP 20/NonDimmable



IP 20/Dimmable

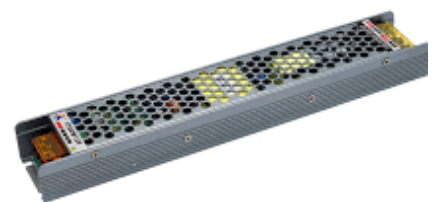

Code	Input Voltage	Output Voltage	Watt	IP Rating	Dimmable
RLC-2A-1A	90-270Vac.	Vdc.-12/24	24	20-67	Yes
RLC-3A-1.5A	90-270Vac.	Vdc.-12/24	36	20-67	Yes
RLC-5A-2.5A	90-270Vac.	Vdc.-12/24	60	20-67	Yes
RLC-8A-4A	90-270Vac.	Vdc.-12/24	100	20-67	Yes
RLC-12A-6A	90-270Vac.	Vdc.-12/24	150	20-67	Yes
RLC-16A-8A	90-270Vac.	Vdc.-12/24	200	20-67	Yes

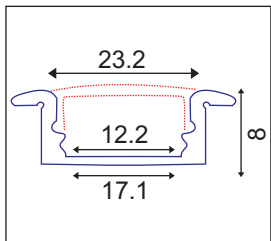
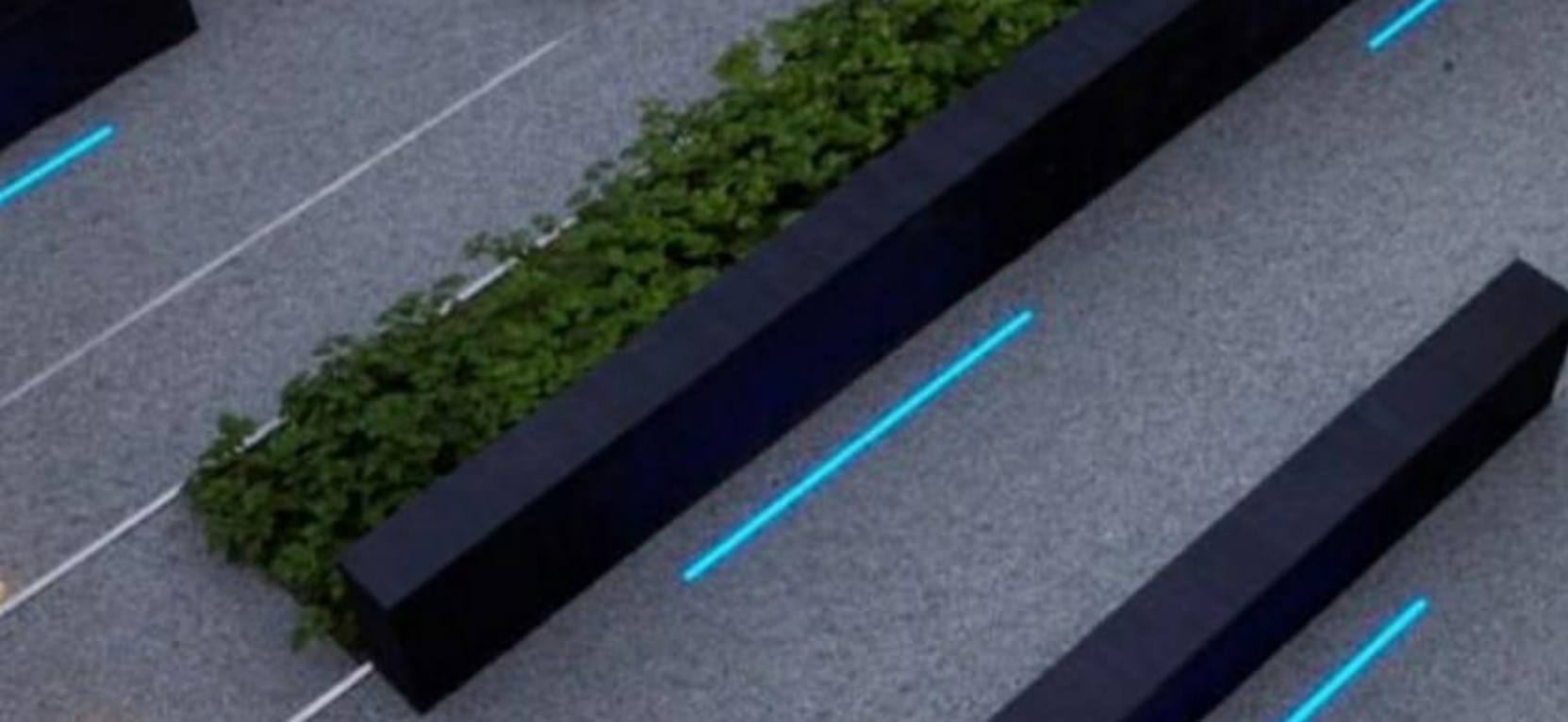

RLC-P1

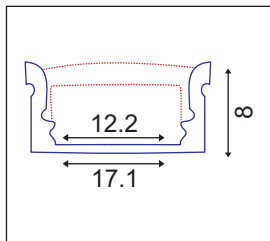

RLC-P2

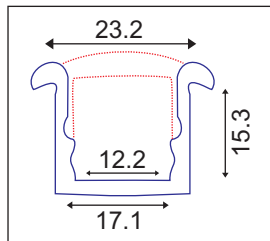

RLC-P3

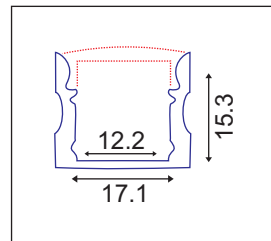

RLC-P4

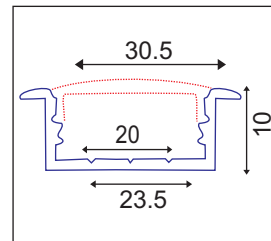

RLC-P5

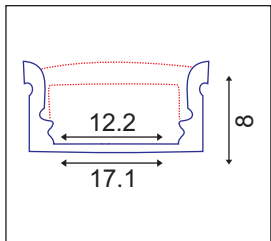

RLC-P6

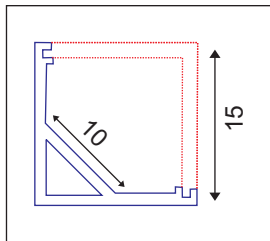

RLC-P7

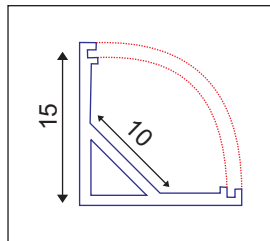

RLC-P8

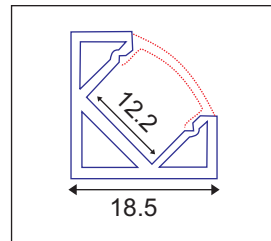

RLC-P9

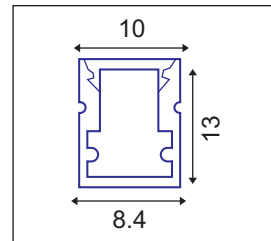

RLC-P10

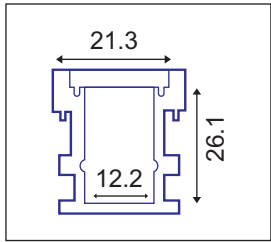

RLC-P11

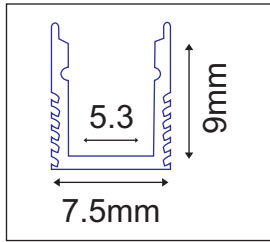

RLC-P12

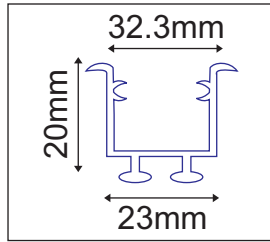

RLC-P13

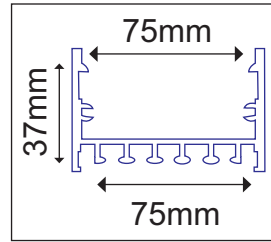

RLC-P14

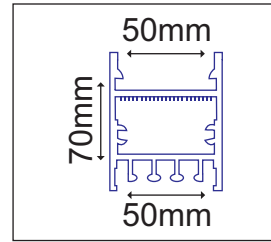

RLC-P15

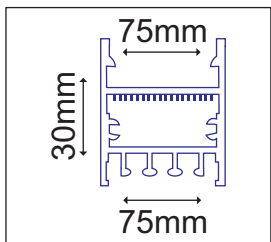

RLC-P16

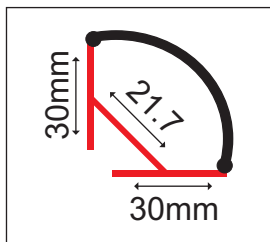

RLC-P17

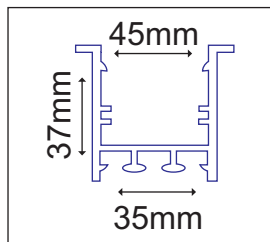

RLC-P18

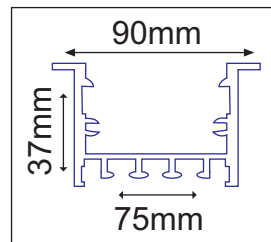

RLC-P19

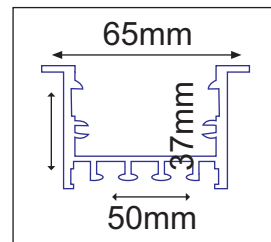

RLC-P20

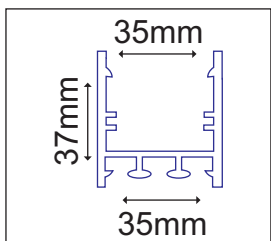

RLC-P21

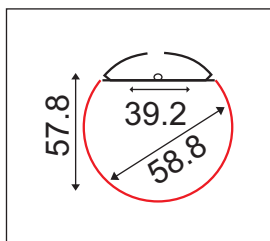

RLC-P22

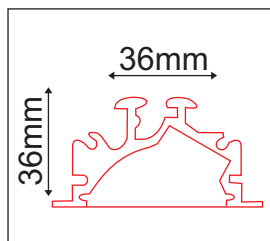

RLC-P23

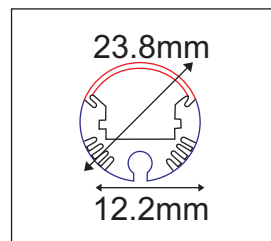

RLC-P24

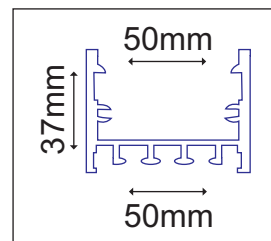

RLC-P25



Your saving is our concern





RLC FLEXIBLE LINEAR LIGHTING

Part Number	Watt	DC Voltage	Colour	Lumen/M	IP Rating
RLC-3528	4w-8w	12v/24v	3K/4K/6K/RGB	240-480	IP-20/IP65/IP68
RLC-2835	6w-12w	12v/24v	3K/4K/6K/RGB	420-840	IP-20/IP65
RLC-5050	12w-24w	12v/24v	3K/4K/6K/RGB	720-1440	IP-20/IP65
RLC-3014	14w-28w	12v/24v	3K/4K/6K/RGB	840-1680	IP-20/IP65
RLC-5630	13w-26w	12v/24v	3K/4K/6K/RGB	980-1800	IP-20

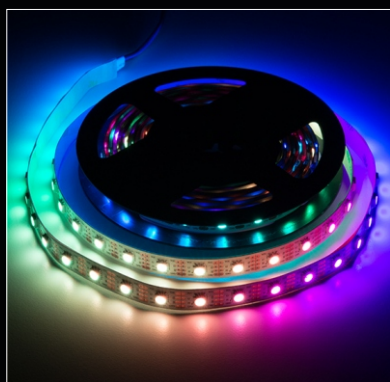



Your saving is our concern

outdoor

c o l l e c t i o n

GROUND BURIAL AND POOL LIGHT SERIES



Your saving is our concern

Watt : 1W / 3W / 6W / 12W
 CCT : 3K / 4K / 6K / RGB
 Lumens : 80 / 240 / 550 / 1100 Lm
 Input Voltage : 220VAC/12VDC/24 VDC
 Angle : 10° / 24° / 35°
 LED : SMD
 Life Span : 50000 Hours
 CRI : >85
 PF : >.90
 Housing Material : Aluminium Body & SS Trim

- RLC-1-01GB • RLC-3-02GB
- RLC-6-03GB • RLC-12-04GB

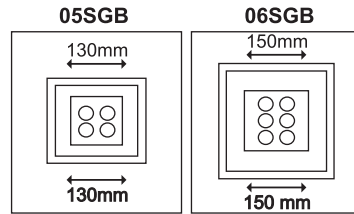
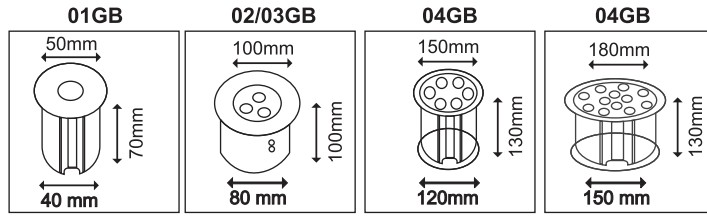

Watt : 4W / 6W
 CCT : 3K / 4K / 6K / RGB
 Lumens : 320 / 550 Lm
 Input Voltage : 220VAC/12VDC/24 VDC
 Angle : 10° / 24° / 35°
 LED : SMD
 Life Span : 50000 Hours
 CRI : >85
 PF : >.90
 Housing Material : Aluminium Body & SS Trim

- RLC-4-05SGB • RLC-6-06SGB

Watt : 1W / 3W / 6W / 12W
 CCT : 3K / 4K / 6K / RGB
 Lumens : 80 / 240 / 550 / 1100 Lm
 Input Voltage : 220VAC/12VDC/24 VDC
 Angle : 10° / 24° / 35°
 LED : SMD
 Life Span : 50000 Hours
 CRI : >85
 PF : >.90
 Housing Material : Stainless Steel / 304 / 316

- RLC-1-07UW • RLC-3-08UW
- RLC-6-09UW • RLC-12-10UW

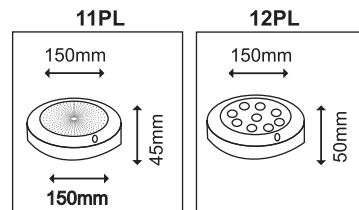
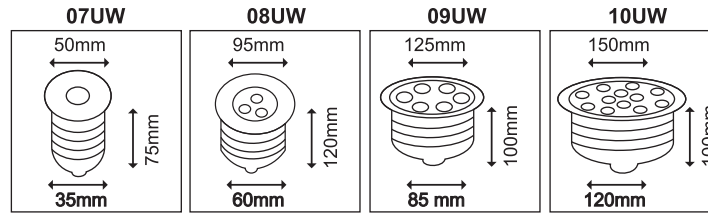

Watt : 12W / 18W
 CCT : 3K / 4K / 6K / RGB
 Lumens : 600 / 1600 Lm
 Input Voltage : 12/ 24 VDC
 Angle : 10° / 24° / 35°
 LED : SMD
 Life Span : 50000 Hours
 CRI : >85
 PF : >.90
 Housing Material : Stainless Steel / 304 / 316

- RLC-12-11PL • RLC-18-12PL

Note : GB-Ground Burial | UW-Under Water | SGB-Square Ground Burial | PL-Pool Light

SPIKE AND FOUNTAIN LIGHT SERIES



Your saving is our concern

Watt : 1W / 3W / 6W / 9W
 CCT : 3K / 4K / 6K / RGB
 Lumens : 80 / 240 / 550 / 800 Lm
 Input Voltage : 220VAC/12VDC/24VDC
 Angle : 10° / 24° / 35°
 LED : SMD
 Life Span : 50000 Hours
 CRI : >85
 PF : >.90
 Housing Material : Stainless Steel / 304 / 316

- RLC-1-13FO ● RLC-3-14FO
- RLC-6-15FO ● RLC-9-16FO

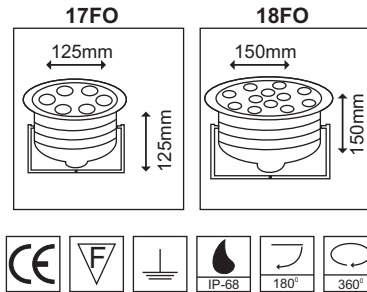
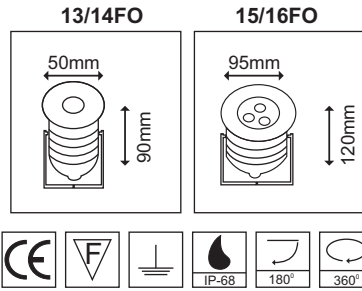

Watt : 18W / 27W
 CCT : 3K / 4K / 6K / RGB
 Lumens : 1600 / 2500 Lm
 Input Voltage : 12 / 24VDC
 Angle : 10° / 24° / 35°
 LED : SMD
 Life Span : 50000 Hours
 CRI : >85
 PF : >.90
 Housing Material : Stainless Steel / 304 / 316

- RLC-18-17FO ● RLC-27-18FO

Watt : 1W / 3W / 6W / 9W
 CCT : 3K / 4K / 6K / RGB
 Lumens : 80 / 240 / 550 / 800 Lm
 Input Voltage : 220VAC/12VDC/24VDC
 Angle : 10° / 24° / 35°
 LED : SMD
 Life Span : 50000 Hours
 CRI : >85
 PF : >.90
 Housing Material : Stainless Steel / 304 / 316

- RLC-1-19SSP ● RLC-3-20SSP
- RLC-6-21SSP ● RLC-9-22SSP

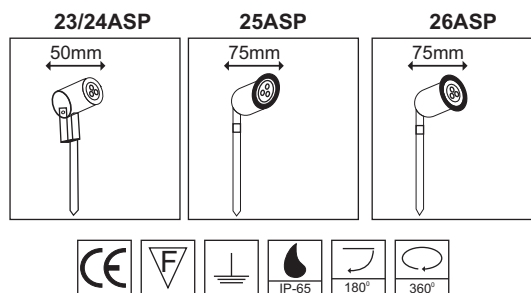
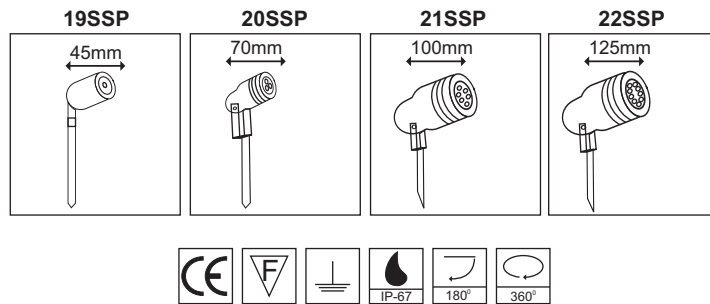

Watt : 1W / 3W / 6W / 9W
 CCT : 3K / 4K / 6K / RGB
 Lumens : 80/240/550/800 Lm
 Input Voltage : 220VAC/12VDC/24VDC
 Angle : 10° / 24° / 35°
 LED : SMD
 Life Span : 50000 Hours
 CRI : >85
 PF : >.90
 Housing Material : Aluminium Body Powder Coated

- RLC-1-23ASP ● RLC-3-24ASP
- RLC-6-25ASP ● RLC-9-26ASP

Note : FO-Fountain Light | ASP-Aluminium Spike | SSP- SS Spike

**BOLLARD AND
STEP LIGHT SERIES**



Your saving is our concern

Watt : 15W
 CCT : 3K
 Lumens : 1000 Lm
 Input Voltage : 220VAC
 Angle : 360°
 LED : SMD
 Life Span : 50000 Hours
 CRI : >85
 PF : >.90
 Housing Material : Aluminium Body Powder Coated

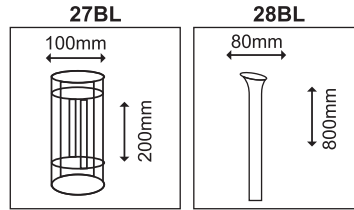

• **RLC-15-27BL** • **RLC-15-28BL**

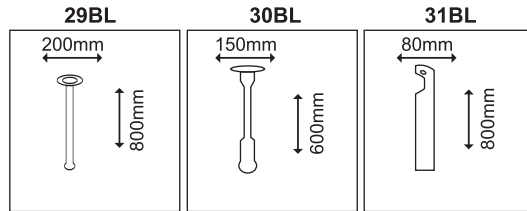

Watt : 9W
 CCT : 3K
 Lumens : 700 Lm
 Input Voltage : 220VAC
 Angle : 360°
 LED : SMD
 Life Span : 50000 Hours
 CRI : >85
 PF : >.90
 Housing Material : Aluminium Body Powder Coated

• **RLC-9-29BL** • **RLC-9-30BL**
 • **RLC-9-31BL**



Watt : 3W
 CCT : 3K / 6K
 Lumens : 150 Lm
 Input Voltage : 220-240 VAC
 Angle : 45°
 LED : SMD
 Life Span : 50000 Hours
 CRI : >85
 PF : >.90
 Housing Material : Aluminium Body Powder Coated

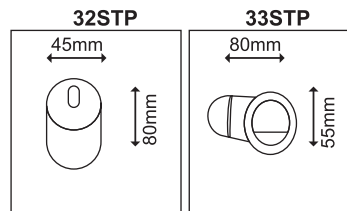

• **RLC-3-32STP** • **RLC-3-33STP**

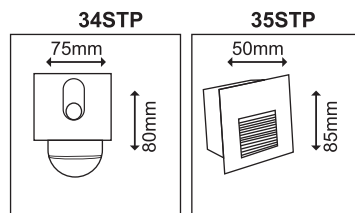

Watt : 3W
 CCT : 3K / 6K
 Lumens : 150 Lm
 Input Voltage : 220-240 VAC
 Angle : 45°
 LED : SMD
 Life Span : 50000 Hours
 CRI : >85
 PF : >.90
 Housing Material : Aluminium Body Powder Coated

• **RLC-3-34STP** • **RLC-3-35STP**



Note : BL-Bollard Light | STP-Step Light

DRIVEOVER AND FOUNTAIN SERIES



Your saving is our concern

Watt : 3W
 CCT : 3K / 6K
 Lumens : 150 Lm
 Input Voltage : 220-240 VAC
 Angle : 45°
 LED : SMD
 Life Span : 50000 Hours
 CRI : >85
 PF : >.90
 Housing Material : Aluminium Body Powder Coated

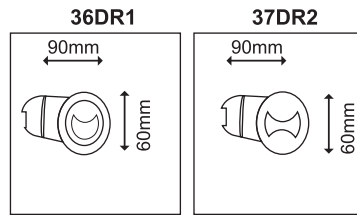

• **RLC-3-36DR1** • **RLC-3-37DR2**

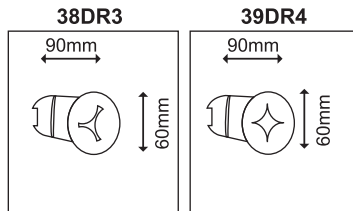

Watt : 3W
 CCT : 3K / 6K
 Lumens : 150 Lm
 Input Voltage : 220-240 VAC
 Angle : 45°
 LED : SMD
 Life Span : 50000 Hours
 CRI : >85
 PF : >.90
 Housing Material : Aluminium Body Powder Coated

• **RLC-3-38DR3** • **RLC-3-39DR4**



Watt : 4W
 CCT : 3K
 Lumens : 350 Lm
 Input Voltage : 220-240 VAC
 Angle : 45°
 LED : SMD
 Life Span : 50000 Hours
 CRI : >85
 PF : >.90
 Housing Material : Aluminium Body Powder Coated

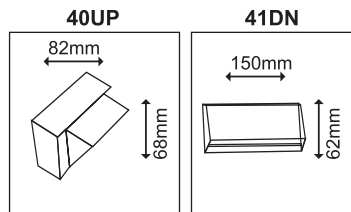

• **RLC-4-40UP** • **RLC-4-41DN**

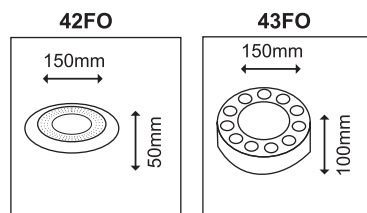

Watt : 9W / 12W
 CCT : 3K / 6K/RGB
 Lumens : 500 / 1100Lm
 Input Voltage : 220-240 VAC
 Angle : 24°/120°
 LED : SMD
 Life Span : 50000 Hours
 CRI : >85
 PF : >.90
 Housing Material : SS & ABS Body

• **RLC-9-42FO** • **RLC-12-43FO**



Note : DR1-Driveover 1Side | DR2-Driveover 2Side | DR3-Driveover 3Side | DR4-Driveover 4Side | UP-UP Light | DN-DownLight | FO-Fountain Light

**WALL LIGHT AND
FLOOD SERIES**



Your saving is our concern

Watt : 9W
 CCT : 3K
 Lumens : 800 Lm
 Input Voltage : 220-240 VAC
 Angle : 10°
 LED : SMD
 Life Span : 50000 Hours
 CRI : >85
 PF : >.90
 Housing Material : Aluminium Powder Coated

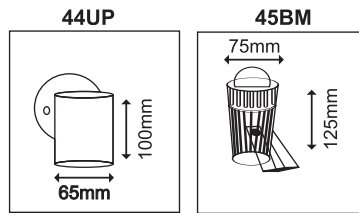

● **RLC-9-44UP** ● **RLC-9-45BM**



Watt : 5WX2
 CCT : 3K / 6K
 Lumens : 950Lm
 Input Voltage : 220-240 VAC
 Angle : 24°
 LED : SMD
 Life Span : 50000 Hours
 CRI : >85
 PF : >.90
 Housing Material : Aluminium Powder Coated

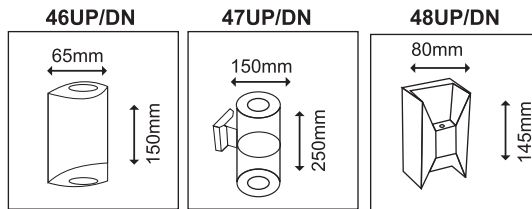

● **RLC-10-46UP/DN** ● **RLC-10-47UP/DN**
 ● **RLC-10-48UP/DN**

Watt : 36W / 50W
 CCT : 3K / 4K / 6K
 Lumens : 3300 / 4500Lm
 Input Voltage : 220-240 VAC
 Angle : 24°
 LED : SMD
 Life Span : 50000 Hours
 CRI : >85
 PF : >.90
 Housing Material : Aluminium Powder Coated

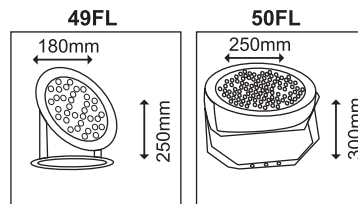

● **RLC-36-49FL** ● **RLC-50-50FL**



Watt : 50W / 100W / 150W
 CCT : 3K / 6K
 Lumens : 4800 / 9000 / 14000Lm
 Input Voltage : 220-240 VAC
 Angle : 45°
 LED : SMD
 Life Span : 50000 Hours
 CRI : >85
 PF : >.90
 Housing Material : Aluminium Powder Coated

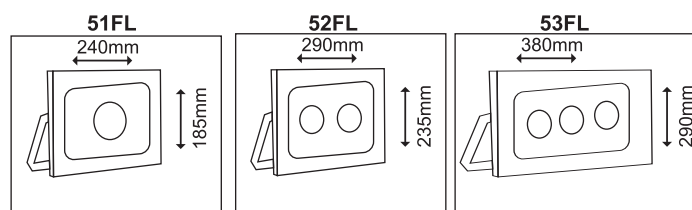

● **RLC-50-51FL** ● **RLC-100-52FL**
 ● **RLC-150-53FL**

Note : UP-UP Light | UP/DN-UP & Down Light | BM-Beamer | FL-Flood Light

WALL AND STREET LIGHT SERIES



Your saving is our concern

Watt : 2WX4
 CCT : 3K
 Lumens : 750Lm
 Input Voltage : 220-240 VAC
 Angle : 10°
 LED : SMD
 Life Span : 50000 Hours
 CRI : >85
 PF : >.90
 Housing Material : Aluminium Powder Coated

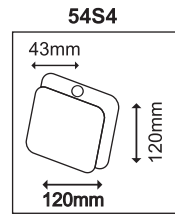

● **RLC-8-54S4**

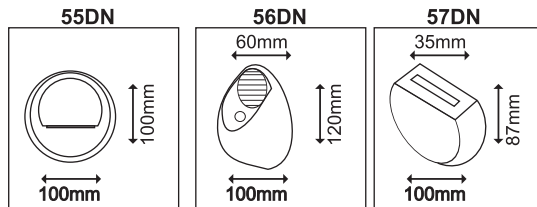

Watt : 3W
 CCT : 3K
 Lumens : 270 Lm
 Input Voltage : 220-240 VAC
 Angle : 45°
 LED : SMD
 Life Span : 50000 Hours
 CRI : >85
 PF : >.90
 Housing Material : Aluminium Powder Coated

● **RLC-3-55DN** ● **RLC-3-56DN**
 ● **RLC-3-57DN**



Watt : 6WX2
 CCT : 3K
 Lumens : 1100Lm
 Input Voltage : 220-240 VAC
 Angle : 12° / 24°
 LED : SMD
 Life Span : 50000 Hours
 CRI : >85
 PF : >.90
 Housing Material : Aluminium Powder Coated

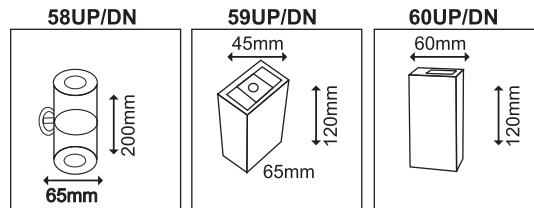

● **RLC-6-58UP/DN** ● **RLC-6-59UP/DN**
 ● **RLC-6-60UP/DN**

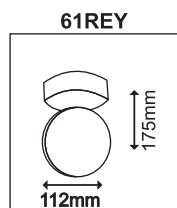

Watt : 9W
 CCT : 3K
 Lumens : 800Lm
 Input Voltage : 220-240 VAC
 Angle : 5°
 LED : SMD
 Life Span : 50000 Hours
 CRI : >85
 PF : >.90
 Housing Material : Aluminium Powder Coated

● **RLC-9-61REY**



Note : S4-4Side | DN-Down Light | UP/DN-Up & Down Light | REY-Rey Light

**INDUSTRIAL AND WALL
GRAZING SERIES**



Your saving is our concern

Watt : 50W
 CCT : 3K / 4K / 6K
 Lumens : 4500 Lm
 Input Voltage : 220-240 VAC
 Angle : 120°
 LED : SMD
 Life Span : 50000 Hours
 CRI : >85
 PF : >.90
 Housing Material : Aluminium Powder Coated

• **RLC-50-62HY** • **RLC-50-63HY**

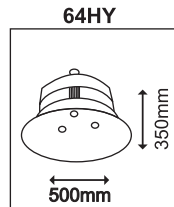
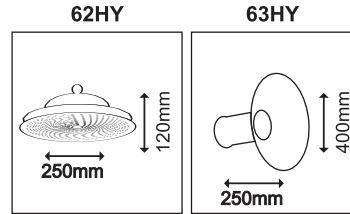

Watt : 150W
 CCT : 3K / 4K / 6K
 Lumens : 14000 Lm
 Input Voltage : 220-240 VAC
 Angle : 120°
 LED : SMD
 Life Span : 50000 Hours
 CRI : >85
 PF : >.90
 Housing Material : Aluminium Powder Coated

• **RLC-150-64HY**

Watt : 18W / 24 W
 CCT : 3K / 4K / 6K / RGB
 Lumens : 1750 / 2300Lm
 Input Voltage : 220-240 VAC
 Angle : 12°/24°/45° / Elliptical
 LED : SMD
 Life Span : 50000 Hours
 CRI : >85
 PF : >.90
 Housing Material : Aluminium Anodised

• **RLC-18-65WW** • **RLC-24-66WW**

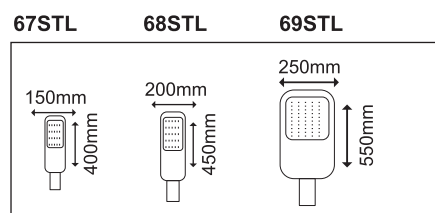
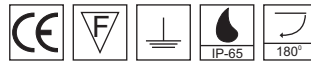
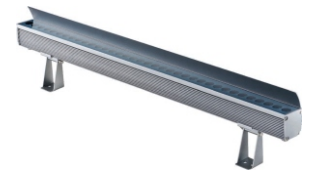
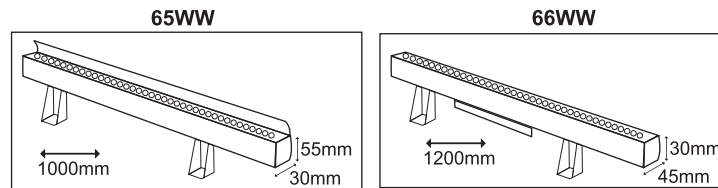

Watt : 30W / 60W / 90W
 CCT : 3K / 6K
 Lumens : 2800/ 5500 / 8000Lm
 Input Voltage : 220-240 VAC
 Angle : 120°
 LED : SMD
 Life Span : 50000 Hours
 CRI : >85
 PF : >.90
 Housing Material : Aluminium Powder Coated

• **RLC-30-67STL** • **RLC-60-68STL**
 • **RLC-90-69STL**

Note : HY-High Bay Light | STL-Street Light | WW-Wall Washer



Your saving is our concern

OUR CLIENTELE





Your saving is our concern

Manufacturer of LED Lights

RLC ARCHITECTURAL LIGHTING

Regd. Office : A-23, Anupam Enclave-2, Saidulajab Extn., New Delhi-110030

Factory : DSIDC-95, Okhla Industrial Area, Phase-I,
New Delhi-110020

Mob. : +91 9871762278, 9354582340

E-mail. : reliablelightcorp@yahoo.in / sales@reliablelightcorp.com

www.reliablelightcorp.com